

3-Level NPC1 Inverter Module

特性/ Features

- 1050V 沟槽栅/场终止技术
1050V Trench with Field Stop Technology
- 低开关损耗
Low switching losses
- V_{cesat} 正温度系数
 V_{cesat} with positive Temperature Coefficient

典型应用/ Applications:

- 储能系统
Energy Storage System
- 光伏逆变器
Solar Inverters
- 不间断电源
Uninterruptable Power Supplies Systems

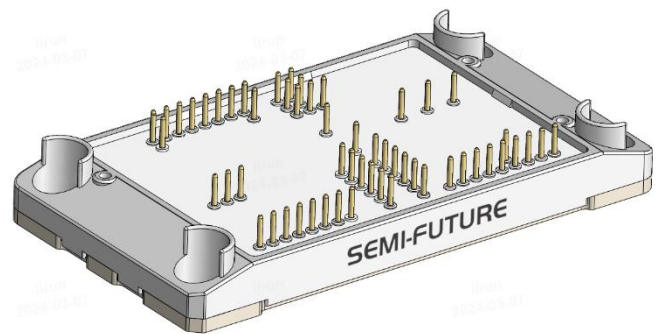
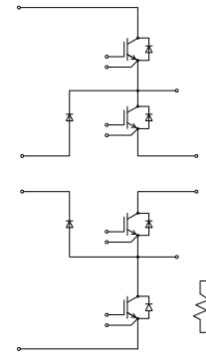

$V_{CE} = 1050V$, $I_{C\ nom} = 400A$ / $I_{CRM} = 800A$

IGBT, T1/T4

最大额定值 / Maximum Ratings

Parameter	Conditions	Symbol	Value	Unit
集电极-发射极电压 Collector-Emitter voltage	$T_{vj} = 25^{\circ}C$	V_{CES}	1050	V
集电极电流 Implemented collector current		I_{CN}	400	A
连续集电极直流电流 Continuous DC collector current	$T_C = 80^{\circ}C$, $T_{vjmax} = 175^{\circ}C$	$I_{C\ nom}$	360	A
集电极重复峰值电流 Repetitive peak collector current	$t_p = 1ms$	I_{CRM}	800	A
栅极-发射极电压 Gate Emitter voltage		V_{GE}	± 20	V
结温 Junction Temperature		T_j	-40 to +175	$^{\circ}C$

特征值 / Characteristic Values

Parameter	Conditions	Symbol	Value			Unit
			Min.	Typ.	Max.	
集电极-发射极饱和电压 Collector-Emitter saturation voltage	$V_{GE} = 15V, I_C = 400A$ $V_{GE} = 15V, I_C = 400A$ $V_{GE} = 15V, I_C = 400A$	$T_{vj} = 25^\circ C$ $T_{vj} = 125^\circ C$ $T_{vj} = 150^\circ C$	V_{CEsat}		1.62 1.96 2.06	2.00 V
栅极-发射极阈值电压 Gate-Emitter threshold voltage	$I_C = 6.5mA, V_{GE} = V_{CE}$	$T_{vj} = 25^\circ C$	$V_{GE(th)}$	4.40	4.70	5.10
栅电荷 Gate charge	$V_{GE} = -15V \dots +15V$		Q_G		1.63	μC
内部栅极电阻 Internal gate resistor			R_{Gint}		0.80	Ω
输入电容 Input capacitance			C_{ies}		28.9	nF
输出电容 Output capacitance	$f = 100KHz, V_{CE} = 25V,$ $V_{GE} = 0V, T_{vj} = 25^\circ C$		C_{oes}		1.07	nF
反向传输电容 Reverse transfer capacitance			C_{res}		0.11	nF
集电极-发射极截止电流 Collector-Emitter cut-off current	$V_{CE} = 1050V, V_{GE} = 0V$	$T_{vj} = 25^\circ C$	I_{CES}			100 μA
栅极-发射极漏电流 Gate-Emitter leakage current	$V_{CE} = 0V, V_{GE} = 20V$	$T_{vj} = 25^\circ C$	I_{GES}			1 μA
开通延迟时间 Turn-on delay time	$I_C = 200A, V_{CE} = 600V$ $V_{GE} = \pm 15V, R_{Gon} = 8\Omega,$ (电感负载) / (Inductive load)	$T_{vj} = 25^\circ C$ $T_{vj} = 125^\circ C$ $T_{vj} = 150^\circ C$	$t_{d on}$		129 124 119	ns
上升时间 Rise time	$I_C = 200A, V_{CE} = 600V$ $V_{GE} = \pm 15V, R_{Gon} = 8\Omega,$ (电感负载) / (Inductive load)	$T_{vj} = 25^\circ C$ $T_{vj} = 125^\circ C$ $T_{vj} = 150^\circ C$	t_r		41 46 48	
关断延迟时间 Turn-off delay time	$I_C = 200A, V_{CE} = 600V$ $V_{GE} = \pm 15V, R_{Goff} = 15\Omega$ (电感负载) / (Inductive load)	$T_{vj} = 25^\circ C$ $T_{vj} = 125^\circ C$ $T_{vj} = 150^\circ C$	$t_{d off}$		546 589 602	
下降时间 Fall time	$I_C = 200A, V_{CE} = 600V$ $V_{GE} = \pm 15V, R_{Goff} = 15\Omega$ (电感负载) / (Inductive load)	$T_{vj} = 25^\circ C$ $T_{vj} = 125^\circ C$ $T_{vj} = 150^\circ C$	t_f		67 99 109	
开通损耗能量 (每脉冲) Turn-on Energy loss per pulse	$I_C = 200A, V_{CE} = 600V$ $V_{GE} = \pm 15V, R_{Gon} = 8\Omega,$ $di/dt = 3400A/\mu s (T_{vj} = 150^\circ C)$	$T_{vj} = 25^\circ C$ $T_{vj} = 125^\circ C$ $T_{vj} = 150^\circ C$	E_{on}		13.5 16.9 18.6	mJ
关断损耗能量 (每脉冲) Turn-off Energy loss per pulse	$I_C = 200A, V_{CE} = 600V$ $V_{GE} = \pm 15V, R_{Goff} = 15\Omega,$ $dv/dt = 4900V/\mu s (T_{vj} = 150^\circ C)$	$T_{vj} = 25^\circ C$ $T_{vj} = 125^\circ C$ $T_{vj} = 150^\circ C$	E_{off}		8.97 11.9 12.9	
结-散热器 Thermal resistance, junction to heatsink	Thermal grease, Thickness = 100um $\pm 2\%$ = 3.0W/mK		R_{thJH}		0.186	K/W
结-外壳热阻 Thermal resistance, junction to case			R_{thJC}		0.140	

IGBT, T2/T3**最大额定值 / Maximum Ratings**

Parameter	Conditions	Symbol	Value	Unit
集电极-发射极电压 Collector-Emitter voltage	$T_{vj} = 25^{\circ}\text{C}$	V_{CES}	1050	V
集电极电流 Implemented collector current		I_{CN}	400	A
连续集电极直流电流 Continuous DC collector current	$T_C = 80^{\circ}\text{C}, T_{vjmax} = 175^{\circ}\text{C}$	$I_{C\ nom}$	360	A
集电极重复峰值电流 Repetitive peak collector current	$t_p = 1\text{ms}$	I_{CRM}	800	A
栅极-发射极电压 Gate Emitter voltage		V_{GE}	± 20	V
结温 Junction Temperature		T_j	-40 to +175	$^{\circ}\text{C}$

特征值 / Characteristic Values

Parameter	Conditions	Symbol	Value			Unit	
			Min.	Typ.	Max.		
集电极-发射极饱和电压 Collector-Emitter saturation voltage	$V_{GE} = 15\text{V}, I_C = 400\text{A}$ $V_{GE} = 15\text{V}, I_C = 400\text{A}$ $V_{GE} = 15\text{V}, I_C = 400\text{A}$	$T_{vj} = 25^{\circ}\text{C}$ $T_{vj} = 125^{\circ}\text{C}$ $T_{vj} = 150^{\circ}\text{C}$	V_{CESat}	1.63 1.97 2.07	2.00	V	
栅极-发射极阈值电压 Gate-Emitter threshold voltage	$I_C = 6.5\text{mA}, V_{GE} = V_{CE}$	$T_{vj} = 25^{\circ}\text{C}$	$V_{GE(th)}$	4.40	4.70	5.10	
栅电荷 Gate charge	$V_{GE} = -15\text{V} \dots +15\text{V}$			1.63		μC	
内部栅极电阻 Internal gate resistor				0.80		Ω	
输入电容 Input capacitance			C_{ies}	28.9		nF	
反向传输电容 Reverse transfer capacitance	$f = 100\text{KHz}, V_{CE} = 25\text{V},$ $V_{GE} = 0\text{V}, T_{vj} = 25^{\circ}\text{C}$		C_{oes}	1.07		nF	
			C_{res}	0.11		nF	
集电极-发射极截止电流 Collector-Emitter cut-off current	$V_{CE} = 1050\text{V}, V_{GE} = 0\text{V}$	$T_{vj} = 25^{\circ}\text{C}$	I_{CES}		100	μA	
栅极-发射极漏电流 Gate-Emitter leakage current	$V_{CE} = 0\text{V}, V_{GE} = 20\text{V}$	$T_{vj} = 25^{\circ}\text{C}$	I_{GES}		1	μA	
开通延迟时间 Turn-on delay time	$I_C = 200\text{A}, V_{CE} = 600\text{V}$ $V_{GE} = \pm 15\text{V}, R_{Gon} = 8\Omega,$ (电感负载) / (Inductive load)	$T_{vj} = 25^{\circ}\text{C}$ $T_{vj} = 125^{\circ}\text{C}$ $T_{vj} = 150^{\circ}\text{C}$	t_{don}	131 124 115		ns	
上升时间 Rise time	$I_C = 200\text{A}, V_{CE} = 600\text{V}$ $V_{GE} = \pm 15\text{V}, R_{Gon} = 8\Omega,$ (电感负载) / (Inductive load)	$T_{vj} = 25^{\circ}\text{C}$ $T_{vj} = 125^{\circ}\text{C}$ $T_{vj} = 150^{\circ}\text{C}$	t_r	45 52 55			

关断延迟时间 Turn-off delay time	$I_C = 200A, V_{CE} = 600V$ $V_{GE} = \pm 15V, R_{Goff} = 15\Omega$ (电感负载) / (Inductive load)	$T_{vj} = 25^\circ C$ $T_{vj} = 125^\circ C$ $T_{vj} = 150^\circ C$	$t_{d\ off}$		550 594 611		
下降时间 Fall time	$I_C = 200A, V_{CE} = 600V$ $V_{GE} = \pm 15V, R_{Goff} = 15\Omega$ (电感负载) / (Inductive load)	$T_{vj} = 25^\circ C$ $T_{vj} = 125^\circ C$ $T_{vj} = 150^\circ C$	t_f		60 87 97		
开通损耗能量 (每脉冲) Turn-on Energy loss per pulse	$I_C = 200A, V_{CE} = 600V$ $V_{GE} = \pm 15V, R_{Gon} = 8\Omega,$ $di/dt = 3000A/\mu s(T_{vj} = 150^\circ C)$	$T_{vj} = 25^\circ C$ $T_{vj} = 125^\circ C$ $T_{vj} = 150^\circ C$	E_{on}		12.7 15.8 17.4		mJ
关断损耗能量 (每脉冲) Turn-off Energy loss per pulse	$I_C = 200A, V_{CE} = 600V$ $V_{GE} = \pm 15V, R_{Goff} = 15\Omega,$ $dv/dt = 4800V/\mu s(T_{vj} = 150^\circ C)$	$T_{vj} = 25^\circ C$ $T_{vj} = 125^\circ C$ $T_{vj} = 150^\circ C$	E_{off}		9.10 12.3 13.3		
结-散热器 Thermal resistance, junction to heatsink	Thermal grease, Thickness = 100um $\pm 2\%$ = 3.0W/mK		R_{thJH}		0.189		K/W
结-外壳热阻 Thermal resistance, junction to case			R_{thJC}		0.142		

二极管, D5/D6

最大额定值 / Maximum Ratings

Parameter	Conditions	Symbol	Value	Unit
反向重复峰值电压 Repetitive peak reverse voltage	$T_{vj} = 25^\circ C$	V_{RRM}	1050	V
正向电流 Implemented forward current		I_{FN}	400	A
连续正向直流电流 Continuous DC forward current	$T_C = 80^\circ C, T_{vjmax} = 175^\circ C$	I_F	280	A
正向重复峰值电流 Repetitive peak forward current	$t_p = 1ms$	I_{FRM}	800	A
I^2t 值 I^2t -value	$t_p = 10ms, \sin 180^\circ, T_j = 125^\circ C$	I^2t	9300	A ² S
结温 Junction Temperature		T_j	-40 to +175	$^\circ C$

特征值 / Characteristic Values

Parameter	Conditions	Symbol	Value			Unit
			Min.	Typ.	Max.	
正向电压 Forward voltage	$I_F = 400A, V_{GE} = 0V$ $I_F = 400A, V_{GE} = 0V$ $I_F = 400A, V_{GE} = 0V$	$T_{vj} = 25^\circ C$ $T_{vj} = 125^\circ C$ $T_{vj} = 150^\circ C$	V_F		2.31 2.56 2.55	V
反向恢复峰值电流 Peak reverse recovery current	$I_F = 200A,$ $-di_F/dt = 4900A/\mu s$ ($T_{vj} = 150^\circ C$) $V_R = 600V, V_{GE} = -15V$	$T_{vj} = 25^\circ C$ $T_{vj} = 125^\circ C$ $T_{vj} = 150^\circ C$	I_{RM}		144 170 179	A
恢复电荷 Recovered charge	$I_F = 200A,$ $-di_F/dt = 3900A/\mu s$ ($T_{vj} = 150^\circ C$) $V_R = 600V, V_{GE} = -15V$	$T_{vj} = 25^\circ C$ $T_{vj} = 125^\circ C$ $T_{vj} = 150^\circ C$	Q_{rr}		9.64 18.4 21.7	μC

反向恢复损耗（每脉冲） Reverse recovered energy	$I_F = 200A$, $-di_F/dt = 3900A/\mu s$ ($T_{vj} = 150^\circ C$) $V_R = 600V$, $V_{GE} = -15V$	$T_{vj} = 25^\circ C$ $T_{vj} = 125^\circ C$ $T_{vj} = 150^\circ C$	E_{rec}	2.52 5.64 6.88		mJ
结-散热器 Thermal resistance, junction to heatsink	Thermal grease, Thickness = 100um $\pm 2\%$ = 3.0W/mK		R_{thJH}	0.262		K/W
结-外壳热阻 Thermal resistance, junction to case			R_{thJC}	0.212		

二极管, D1/D4

最大额定值 / Maximum Ratings

Parameter	Conditions	Symbol	Value	Unit
反向重复峰值电压 Repetitive peak reverse voltage	$T_{vj} = 25^\circ C$	V_{RRM}	1050	V
正向电流 Implemented forward current		I_{FN}	400	A
连续正向直流电流 Continuous DC forward current	$T_C = 80^\circ C$, $T_{vjmax} = 175^\circ C$	I_F	280	A
正向重复峰值电流 Repetitive peak forward current	$t_p = 1ms$	I_{FRM}	800	A
I^2t 值 I^2t -value	$t_p = 10ms$, $\sin 180^\circ$, $T_j = 125^\circ C$	I^2t	9300	A ² S
结温 Junction Temperature		T_j	-40 to +175	$^\circ C$

特征值 / Characteristic Values

Parameter	Conditions	Symbol	Value			Unit
			Min.	Typ.	Max.	
正向电压 Forward voltage	$I_F = 400A$, $V_{GE} = 0V$ $I_F = 400A$, $V_{GE} = 0V$ $I_F = 400A$, $V_{GE} = 0V$	$T_{vj} = 25^\circ C$ $T_{vj} = 125^\circ C$ $T_{vj} = 150^\circ C$	V_F	2.31 2.56 2.55		V
反向恢复峰值电流 Peak reverse recovery current	$I_F = 200A$, $-di_F/dt = 5000A/\mu s$ ($T_{vj} = 150^\circ C$) $V_R = 600V$, $V_{GE} = -15V$	$T_{vj} = 25^\circ C$ $T_{vj} = 125^\circ C$ $T_{vj} = 150^\circ C$	I_{RM}	138 150 160		A
恢复电荷 Recovered charge	$I_F = 200A$, $-di_F/dt = 5000A/\mu s$ ($T_{vj} = 150^\circ C$) $V_R = 600V$, $V_{GE} = -15V$	$T_{vj} = 25^\circ C$ $T_{vj} = 125^\circ C$ $T_{vj} = 150^\circ C$	Q_{rr}	9.79 18.7 22.0		μC
反向恢复损耗（每脉冲） Reverse recovered energy	$I_F = 200A$, $-di_F/dt = 5000A/\mu s$ ($T_{vj} = 150^\circ C$) $V_R = 600V$, $V_{GE} = -15V$	$T_{vj} = 25^\circ C$ $T_{vj} = 125^\circ C$ $T_{vj} = 150^\circ C$	E_{rec}	2.55 5.64 6.89		mJ
结-散热器 Thermal resistance, junction to heatsink	Thermal grease, Thickness = 100um $\pm 2\%$ = 3.0W/mK		R_{thJH}	0.259		K/W
结-外壳热阻 Thermal resistance, junction to case			R_{thJC}	0.207		

二极管,D2/D3

最大额定值 / Maximum Ratings

Parameter	Conditions	Symbol	Value	Unit
反向重复峰值电压 Repetitive peak reverse voltage	$T_{vj} = 25^{\circ}\text{C}$	V_{RRM}	1050	V
正向电流 Implemented forward current		I_{FN}	300	A
连续正向直流电流 Continuous DC forward current	$T_C = 80^{\circ}\text{C}, T_{vjmax} = 175^{\circ}\text{C}$	I_F	210	A
正向重复峰值电流 Repetitive peak forward current	$t_p = 1\text{ms}$	I_{FRM}	600	A
I^2t 值 I^2t -value	$t_p = 10\text{ms}, \sin 180^{\circ}, T_j = 125^{\circ}\text{C}$	I^2t	6100	A^2S
结温 Junction Temperature		T_j	-40 to +175	$^{\circ}\text{C}$

特征值 / Characteristic Values

Parameter	Conditions	Symbol	Value			Unit
			Min.	Typ.	Max.	
正向电压 Forward voltage	$I_F = 300\text{A}, V_{GE} = 0\text{V}$ $I_F = 300\text{A}, V_{GE} = 0\text{V}$ $I_F = 300\text{A}, V_{GE} = 0\text{V}$	$T_{vj} = 25^{\circ}\text{C}$ $T_{vj} = 125^{\circ}\text{C}$ $T_{vj} = 150^{\circ}\text{C}$	V_F	2.27 2.50 2.48		V
反向恢复峰值电流 Peak reverse recovery current	$I_F = 200\text{A},$ $-\text{di}_F/\text{dt} = 3900\text{A}/\mu\text{s}$ ($T_{vj} = 150^{\circ}\text{C}$) $V_R = 600\text{V}, V_{GE} = -15\text{V}$	$T_{vj} = 25^{\circ}\text{C}$ $T_{vj} = 125^{\circ}\text{C}$ $T_{vj} = 150^{\circ}\text{C}$	I_{RM}	131 144 150		A
恢复电荷 Recovered charge	$I_F = 200\text{A},$ $-\text{di}_F/\text{dt} = 3500\text{A}/\mu\text{s}$ ($T_{vj} = 150^{\circ}\text{C}$) $V_R = 600\text{V}, V_{GE} = -15\text{V}$	$T_{vj} = 25^{\circ}\text{C}$ $T_{vj} = 125^{\circ}\text{C}$ $T_{vj} = 150^{\circ}\text{C}$	Q_F	8.94 16.4 19.2		μC
反向恢复损耗 (每脉冲) Reverse recovered energy	$I_F = 200\text{A},$ $-\text{di}_F/\text{dt} = 3500\text{A}/\mu\text{s}$ ($T_{vj} = 150^{\circ}\text{C}$) $V_R = 600\text{V}, V_{GE} = -15\text{V}$	$T_{vj} = 25^{\circ}\text{C}$ $T_{vj} = 125^{\circ}\text{C}$ $T_{vj} = 150^{\circ}\text{C}$	E_{rec}	2.39 5.17 6.23		mJ
结-散热器 Thermal resistance, junction to heatsink	Thermal grease, Thickness = 100 $\mu\text{m} \pm 2\%$ = 3.0W/mK	R_{thJH}		0.316		K/W
结-外壳热阻 Thermal resistance, junction to case		R_{thJC}		0.262		

负温度系数热敏电阻/NTC-Thermistor

特征值/Characteristic Values

Parameter	Conditions	Value			Unit
R25	T = 25°C		5		KΩ
ΔR/R		-5		5	%
B-value	B (25/50), tolerance ±3%		3375		K
B-value	B (25/100), tolerance ±3%		3433		K

模块 / Module

Parameter	Conditions	Symbol	Value			Unit
绝缘测试电压 Isolation test voltage	RMS, f = 50Hz, t = 1min	V _{ISOL}	3200			V
内部绝缘 Internal isolation			Al ₂ O ₃			
爬电距离 Creepage distance	端子至散热器 / terminal to heatsink		11.5			mm
	端子-端子/Terminal to terminal		6.8			
电气间隙 Clearance	端子至散热器 / terminal to heatsink		9.4			mm
	端子-端子/Terminal to terminal		5.5			
相对电痕指数 Comperative tracking index		CTI	> 400			
相对温度指数 (电) RTI Elec.	housing	RTI	140			
储存温度 Storage temperature		T _{stg}	-40		125	°C
模块安装的扭矩 Mounting torque for modul mounting		M	3.0		5.0	Nm
重量 Weight		W		267		g

IGBT T1/T4



图 1. 典型输出特性 ($T_{vj} = 25^{\circ}\text{C}$)
Figure 1. Typical output characteristics ($T_{vj} = 25^{\circ}\text{C}$)



图 2. 典型输出特性 ($T_{vj} = 150^{\circ}\text{C}$)
Figure 2. Typical output characteristics ($T_{vj} = 150^{\circ}\text{C}$)

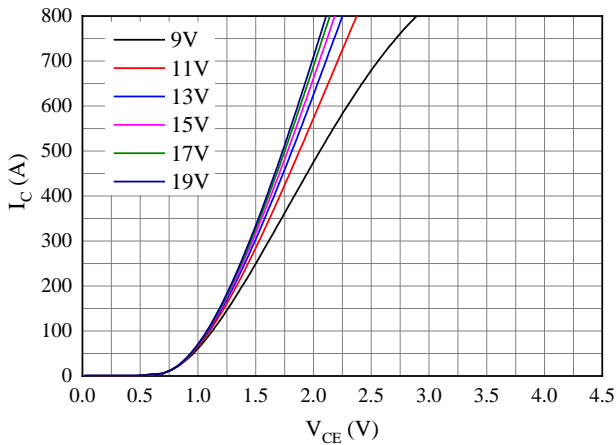

图 3. 典型输出特性 ($V_{GE} = 15\text{V}$)
Figure 3. Typical output characteristics ($V_{GE} = 15\text{V}$)

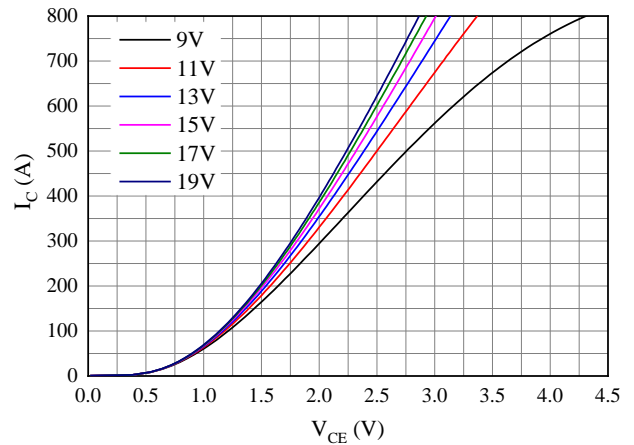

图 4. 典型传输特性 ($V_{CE} = 20\text{V}$)
Figure 4. Typical transfer characteristic ($V_{CE} = 20\text{V}$)

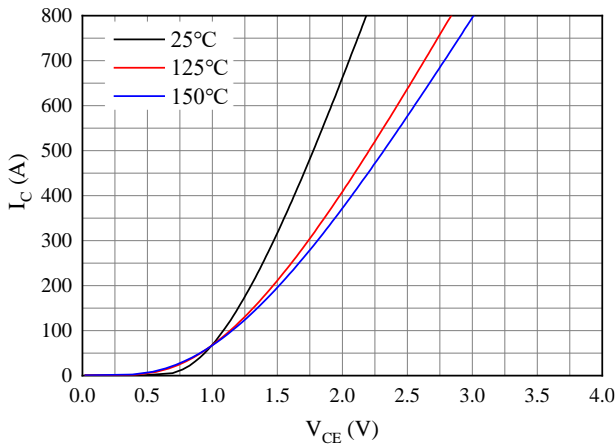

图 5. 开关损耗
Figure 5. Switching losses of IGBT,
 $V_{GE} = \pm 15\text{V}$, $R_{gon} = 8\Omega$, $R_{goff} = 15\Omega$, $V_{CE} = 600\text{V}$

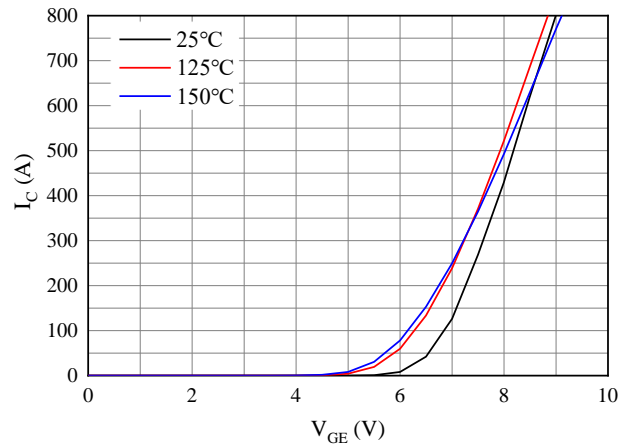

图 6. 开关损耗
Figure 6. Switching losses of IGBT,
 $V_{GE} = \pm 15\text{V}$, $I_c = 200\text{A}$, $V_{CE} = 600\text{V}$

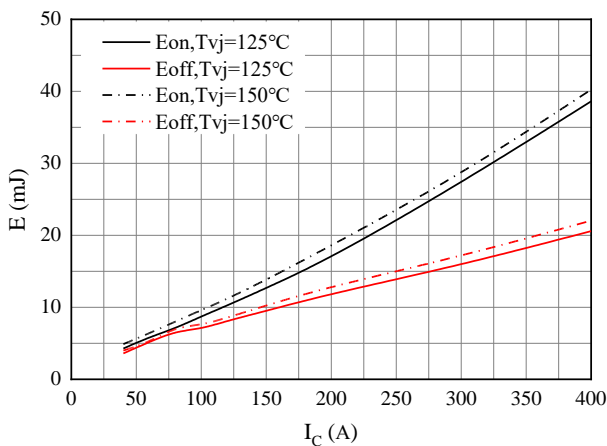

图 7. 瞬态热阻抗 IGBT

Figure 7. Transient thermal impedance IGBT,
 $Z_{thJC} = f(t)$

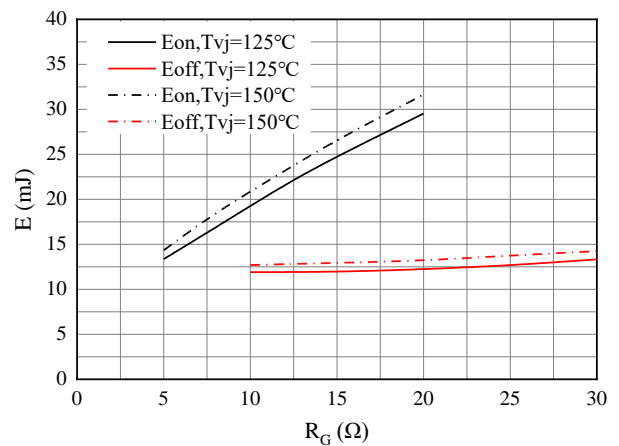

图 8. 电容特性

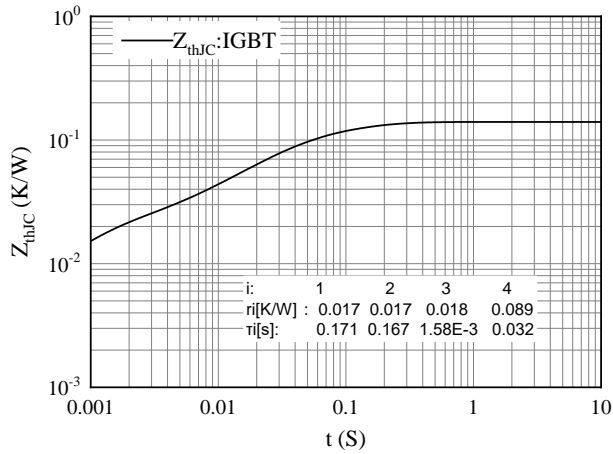
Figure 8. Capacitance characteristic

IGBT T2/T3

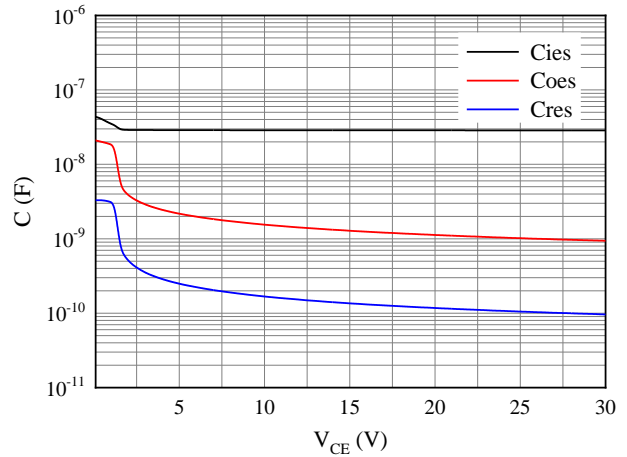

图 9. 典型输出特性 ($T_{vj} = 25^{\circ}\text{C}$)

Figure 9. Typical output characteristics ($T_{vj} = 25^{\circ}\text{C}$)

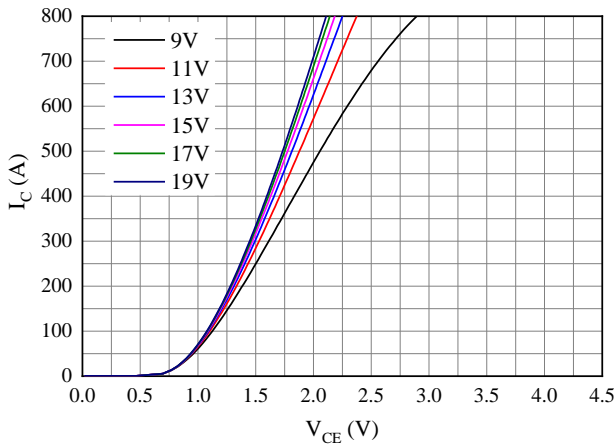

图 10. 典型输出特性 ($T_{vj} = 150^{\circ}\text{C}$)

Figure 10. Typical output characteristics ($T_{vj} = 150^{\circ}\text{C}$)

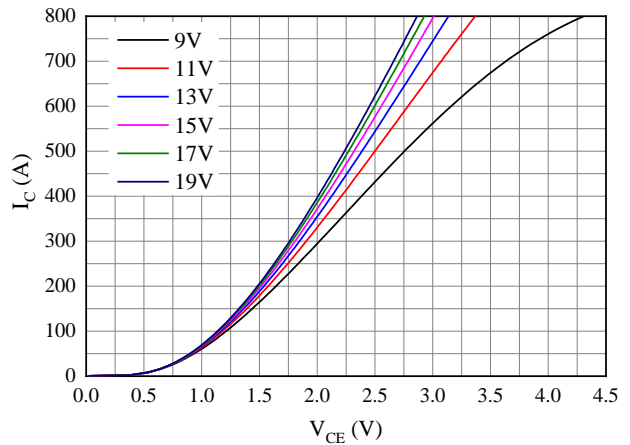

图 11. 典型输出特性 ($V_{GE} = 15\text{V}$)

Figure 11. Typical output characteristics ($V_{GE} = 15\text{V}$)

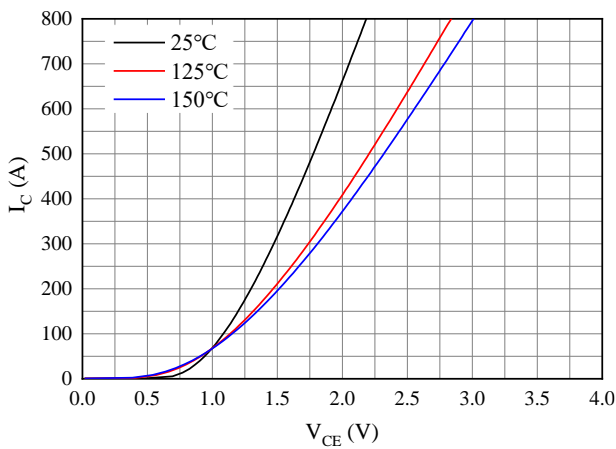

图 12. 典型传输特性 ($V_{CE} = 20\text{V}$)

Figure 12. Typical transfer characteristic ($V_{CE} = 20\text{V}$)

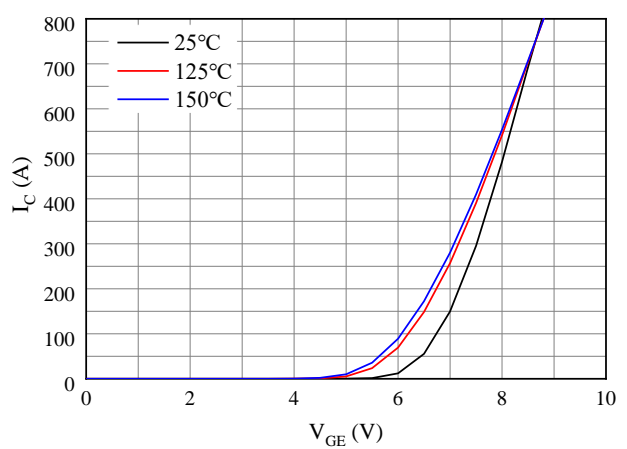

图 13. 开关损耗

Figure 13. Switching losses of IGBT,
 $V_{GE} = \pm 15V, R_{gon} = 8\Omega, R_{goff} = 15\Omega, V_{CE} = 600V$

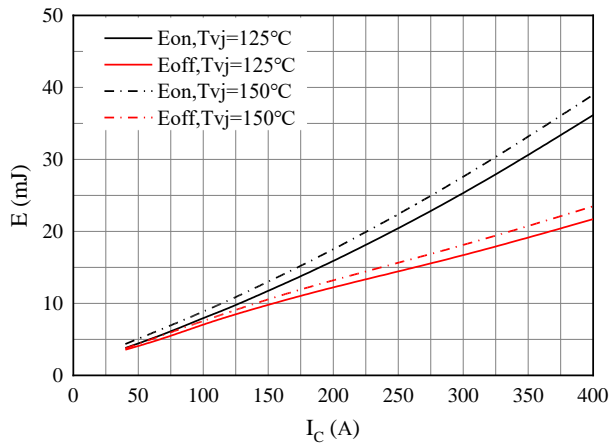

图 14. 开关损耗

Figure 14. Switching losses of IGBT,
 $V_{GE} = \pm 15V, I_c = 200A, V_{CE} = 600V$

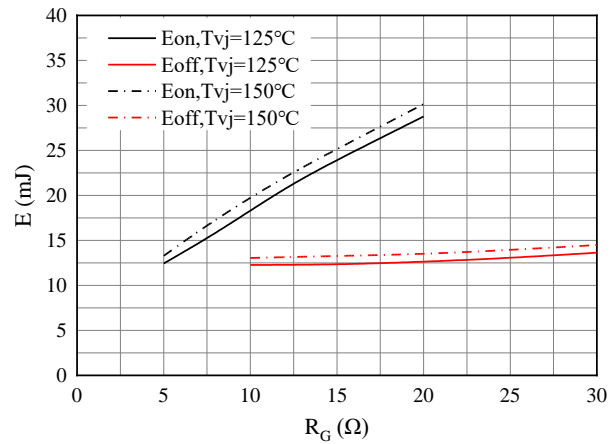

图 15. 瞬态热阻抗 IGBT

Figure 15. Transient thermal impedance IGBT,
 $Z_{thJC} = f(t)$

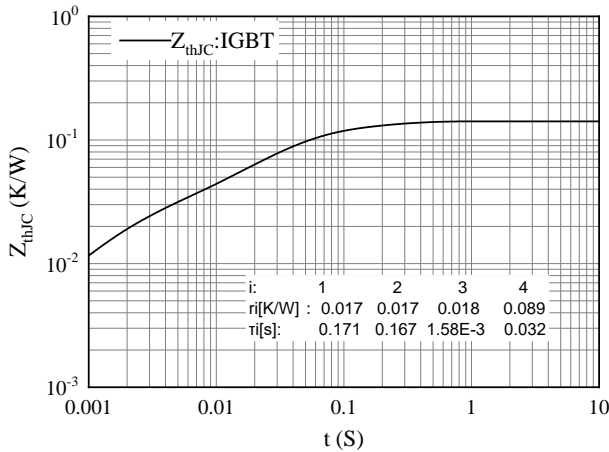

图 16. 电容特性

Figure 16. Capacitance characteristic

二极管 D5/D6

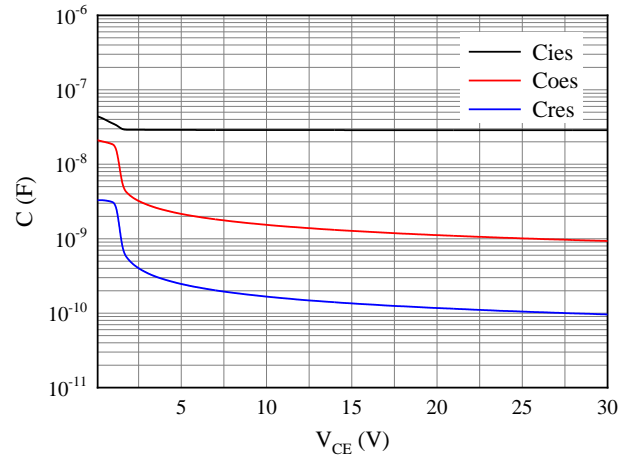

图 21. 正向偏压特性 二极管

Figure 21. Forward characteristic of Diode

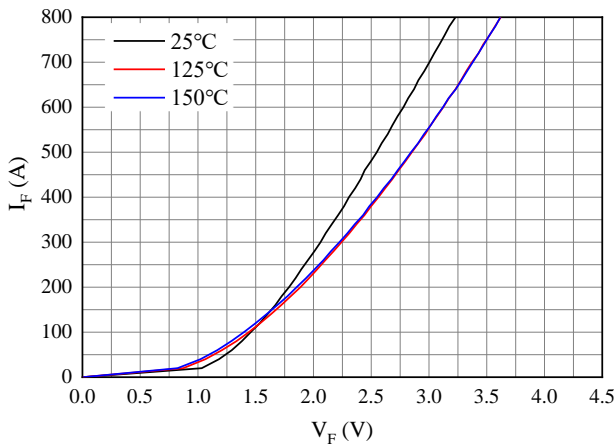

图 22. 开关损耗 二极管

Figure 22. Switching losses of Diode
 $R_{gon} = 8\Omega, V_{CE} = 600V$



图 23. 开关损耗 二极管
Figure 23. Switching losses of Diode
 $I_F = 200\text{A}, V_{CE} = 600\text{V}$

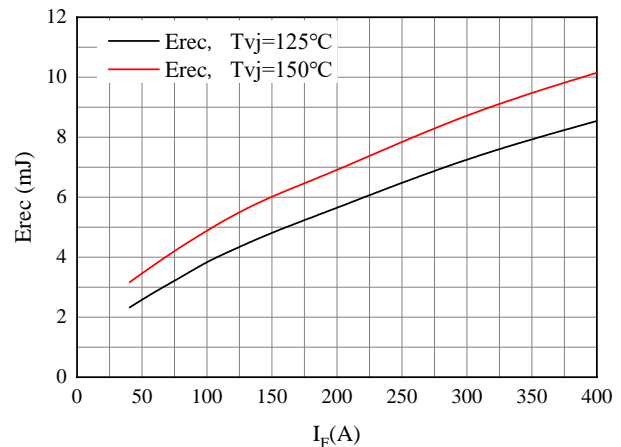

图 24. 瞬态热阻抗 二极管
Figure 24. Transient thermal impedance Diode
 $Z_{thJC} = f(t)$

二极管 D1/D4

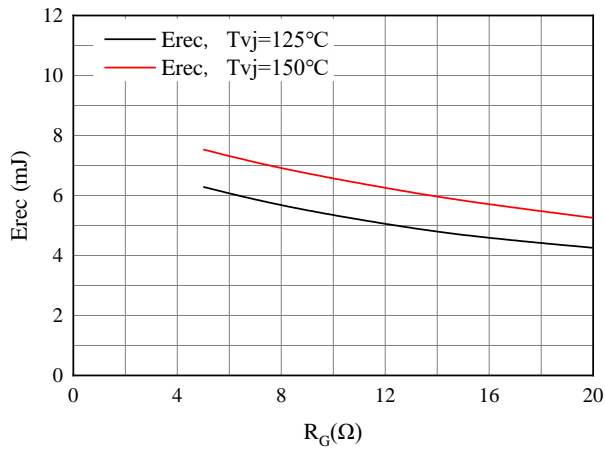

图 17. 正向偏压特性 二极管
Figure 17. Forward characteristic of Diode

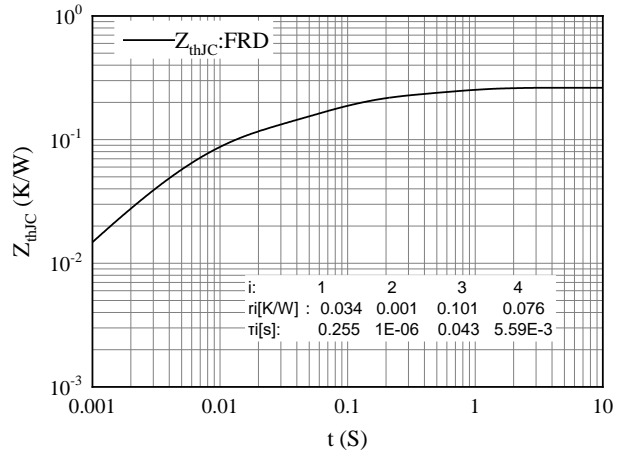

图 18. 开关损耗 二极管
Figure 18. Switching losses of Diode
 $R_{gon} = 8\Omega, V_{CE} = 600\text{V}$

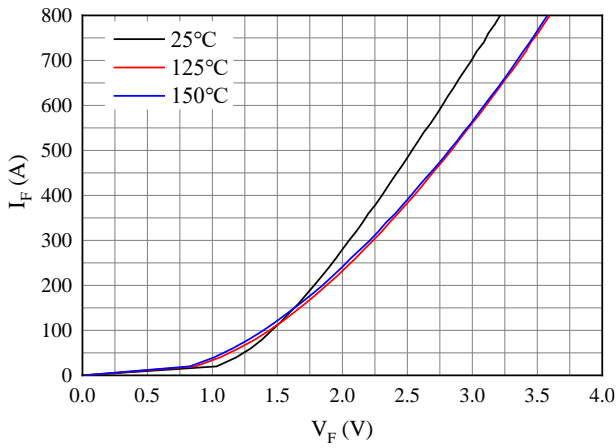

图 19. 开关损耗 二极管
Figure 19. Switching losses of Diode
 $I_F = 200\text{A}, V_{CE} = 600\text{V}$

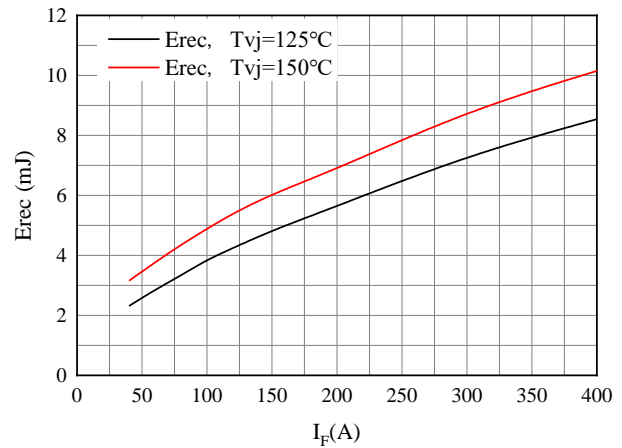

图 20. 瞬态热阻抗 二极管
Figure 20. Transient thermal impedance Diode
 $Z_{thJC} = f(t)$

二极管 D2/D3

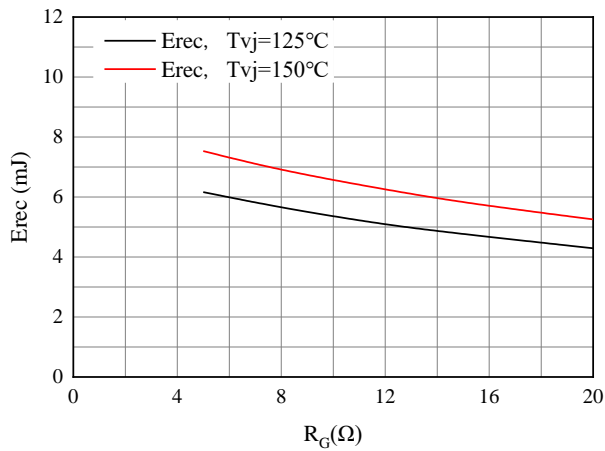

图 21. 正向偏压特性 二极管
Figure 21. Forward characteristic of Diode

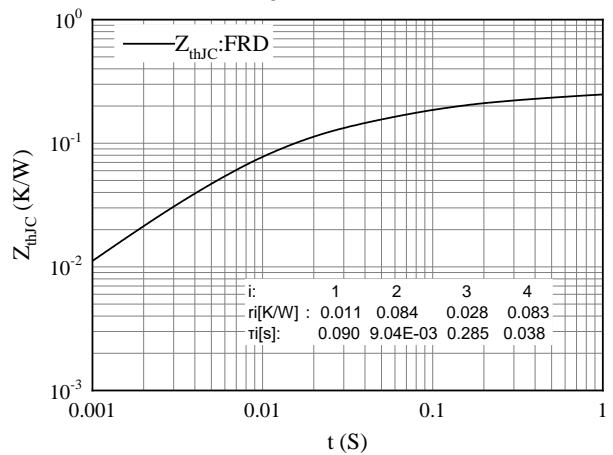

图 22. 开关损耗 二极管
Figure 22. Switching losses of Diode
 $R_{gon} = 8\Omega, V_{CE} = 600V$

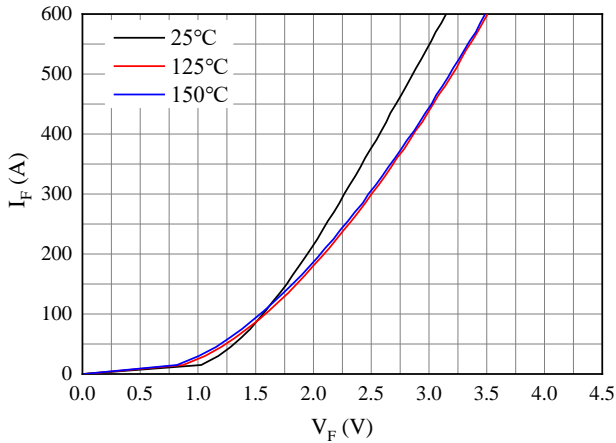

图 23. 开关损耗 二极管
Figure 23. Switching losses of Diode
 $I_F = 200A, V_{CE} = 600V$

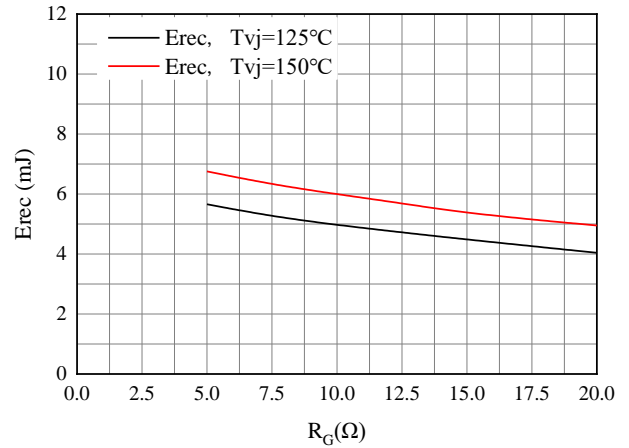

图 24. 瞬态热阻抗 二极管
Figure 24. Transient thermal impedance Diode
 $Z_{thJC} = f(t)$

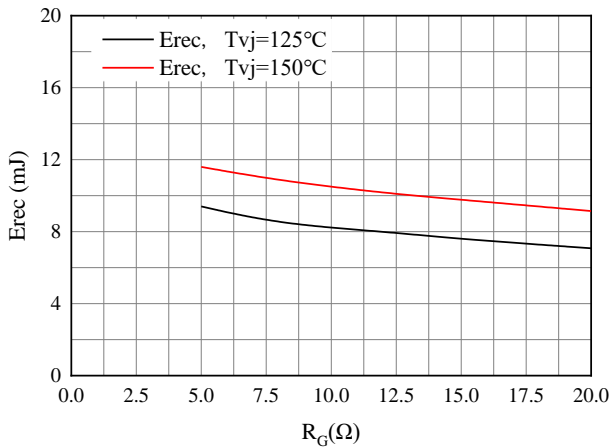

图 25. 负温度系数热敏电阻 温度特性
Figure 25. NTC-Thermistor-temperature characteristic

接线图/Circuit Diagram

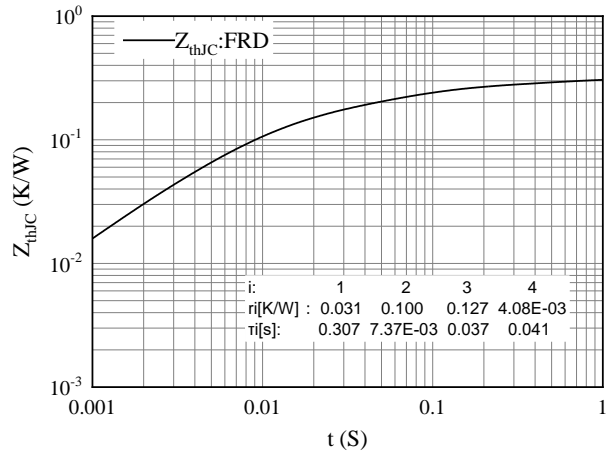

封装尺寸 / Package outlines

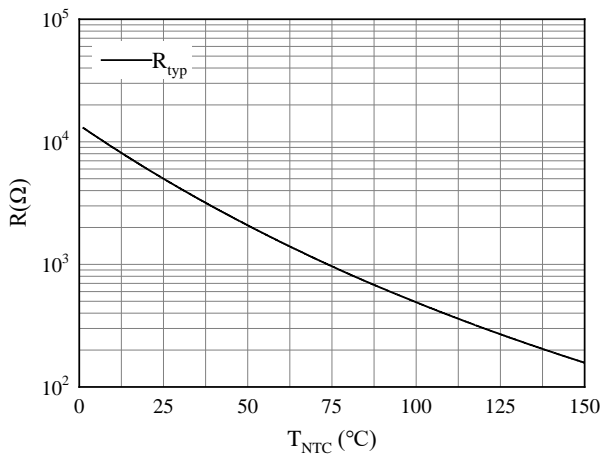
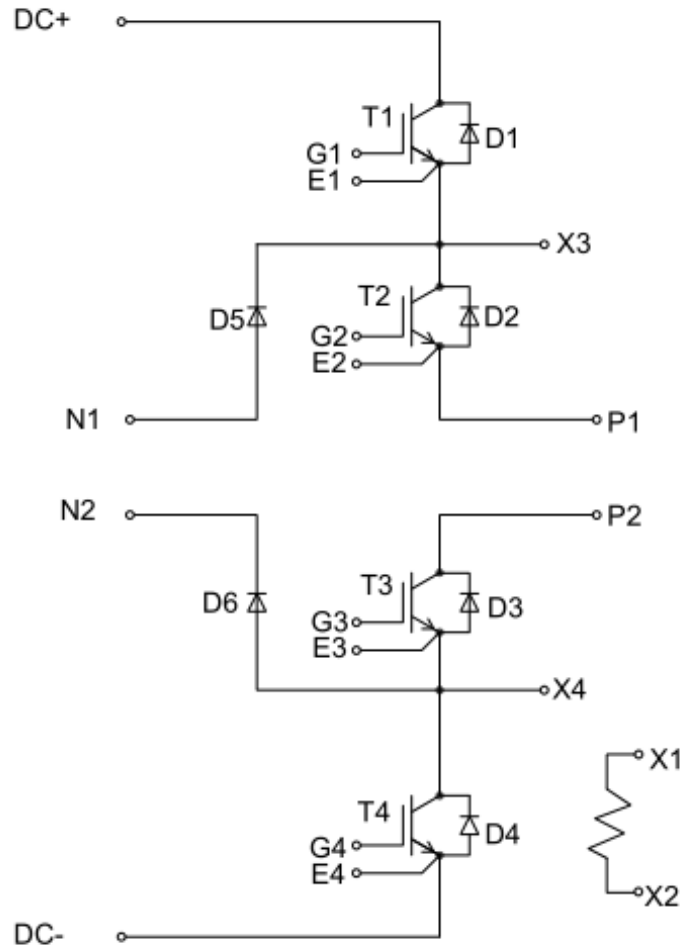